

KOMATSU

EX50

S E R I E S

10-16ton

Diesel Pneumatic-Tyre Trucks
EPA Tier 3/EU Stage IIIA Emission Compliant



www.Komatsu.com

Printed in Japan 1012-4-03shi

KOMATSU[®]

Form No. BR-EX50-004

Materials and specifications are subject to change without notice
KOMATSU is a trademark of Komatsu Ltd. Japan

Environment & Economy is the word for the next generation. EX50 Series is our answer for it.

Komatsu put its technologies and know-how into the design and construction of a new engine, which is a proof of our careful consideration of the next step. With its new cutting edge four key technologies, the new engine provides reliable power with better fuel efficiency for maximum productivity and lowered operating cost while being environment-friendly.



Engine Technologies

Key Technology-1

Electronic Control System

Key Technology-2

Heavy duty HPCR System

Key Technology-3

New Combustion System

Key Technology-4

Air to Air Charge Air Cooling System

10t/11.5t/13.5t/15t/16t

Diesel Pneumatic-Tyre Trucks
EPA Tier 3/EU Stage IIIA Emission Compliant

EX50
S E R I E S

Born of the unsurpassed technologies
Shaped from the deep thoughtfulness for environment.



ENVIRONMENTAL SAFETY

The new engine adopts the latest technologies that supports both reliable power and environment-friendliness

EPA Tier 3/ Euro IIIA compliant SAA6D107E-1 engine adopts Komatsu's latest engine technologies, and dramatically reduces NOx and PM in exhaust. Also, each system successfully interacts for better fuel efficiency and lowered running noises. Reliable fuel filters keep systems performance high and protect components. The engine offer full performance and power even in severe conditions.

- Rated Output : **122kW @ 2,200min⁻¹**
- Maximum Torque : **575Nm @ 1,600min⁻¹**

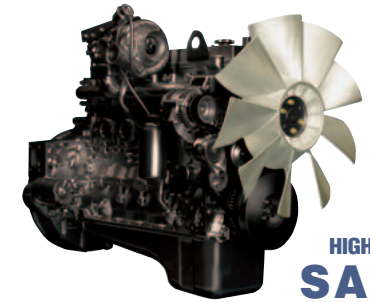

HIGH POWER CLEAN DIESEL ENGINE
SAA6D107E-1

Key Technology-1: Electronic Control System

The center control unit quickly processes signals from various sensors on the vehicle in order to produce a maximum power in any condition, eliminating possible loss in engine performance.

Key Technology-2: Heavy duty HPCR System

High pressure compressed fuel stored in a accumulator chamber, so-called common rail, is injected into each cylinder sufficiently at a proper timing by an ECU (Electric Controlled Unit). This HPCR (High Pressure Common Rail) system promises optimized fuel burning and reduced fuel consumption.

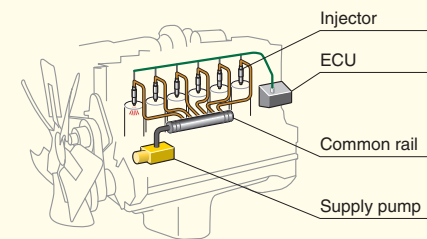

Key Technology-3: New Combustion System

A unique shape of the combustion chamber on the top surface of each piston facilitates complete fuel burning by optimizing conditions, timings and amounts of fuel injection, which helps reduce NOx and PM in exhaust, as well as fuel consumption.

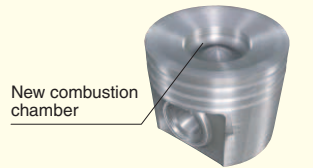

Key Technology-4: Air to Air Charge Air Cooling System

This system cools high temperature air blown by the turbocharger and supplies it to cylinders.

As a result, the system maximizes combustion efficiency and emission performance, facilitating high output while reducing NOx and fuel consumption.

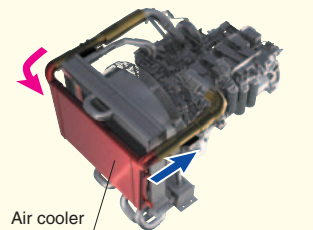

SAFETY

Wet disc brake that safely stop the vehicle in any working conditions (Option)

The EX50 features Komatsu's original wet disc braking system that eliminates weakness of traditional drum brakes. With its built-in waterproof and dustproof mechanism, the braking system also delivers high durability with less brake shoe wearing. Because the braking system is enclosed, it does not require part replacement or overhauls for maintenance.* Regardless of your working conditions, it offers added reliability and safety of the EX50.

*Oil replacement and regular inspections are required.

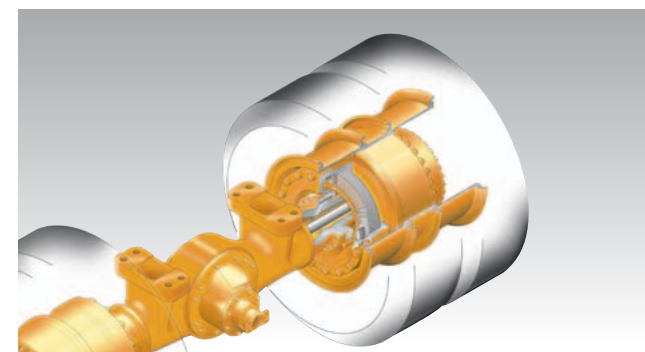

Operator Presence Sensing system automatically stops traveling and lifting when the operator leaves the seat (Option)

To avoid malfunctions and operations in the operator's unstable positions, the Operator Presence Sensing system automatically prevents driving and loading when the operator is unseated. Indicators on the display panel inform the vehicle condition when it stops by the interlock. This mechanism conform with ISO3691-1, one of the worldwide safety standards.

*This system is to safely stop the driving and loading function, and not intended to forcibly brake the vehicle.

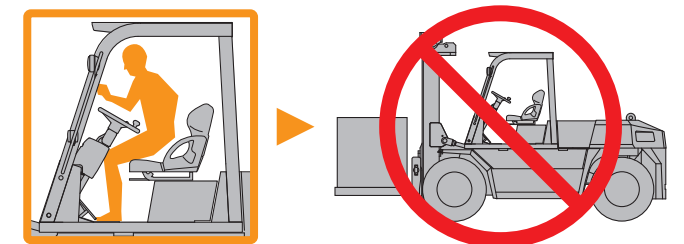

What about ISO3691-1

ISO3691 refers to a series of safety standards for industrial trucks to facilitate safe working.

**Good view, comfort seating and operability.
All designed to deliver the higher level of workability.**



MANEUVERABILITY

Exceptionally high travel speed achieved through use of electrically controlled forward/reverse lever and 3-speed transmission (or optional automatic transmission)

A best-of-breed combination of high-power new engine and powershift 3-speed transmission (or optional automatic transmission) with forward/reverse lever ensures excellent maneuverability and the optimum high-performance combination of travel speed, acceleration, lift speed, and gradability.

- **Traveling Speed** (at the third gear, unloaded) : **32km/h**
- **Gradability** (FD 100) : **38% (21 degrees)**

Top-of-class rated lift speed ensures speedy and efficient work

A top-of-class lift speed can be achieved in both loaded and unloaded states through optimization of the oil-level efficiency of the large-capacity tandem hydraulic pump (common to 10-ton to 16-ton models) as well as use of the new hydraulic circuit (load-sensing valve).

- **Lifting Speed** (Loaded/FD100) : **470mm/s**

COMFORT

Greatly enhanced front/rear visibility achieved by improved top of the counter weight shape and expanded inner width of the mast

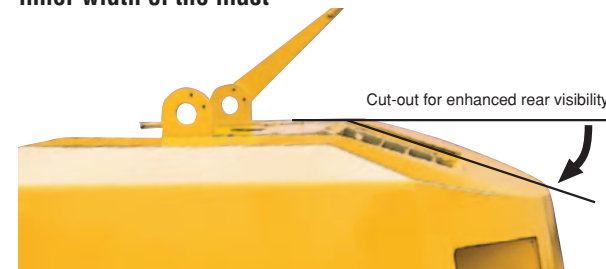

Improvement in the shape of the back portion of the rear weight enhances rearward visibility, which has been a blind spot for the operator. Moreover, arrangement of the chains outside of the mast allows the inner width of the mast to be expanded to 642 mm [25.3 inches] (FD100), ensure the good frontward visibility essential for safe operation.

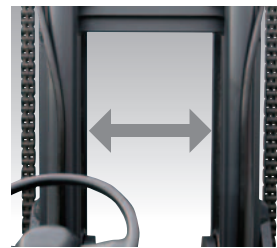

- **Inner width of the mast** (FD100 2-stage view mast) : **642mm [25.3in]**

Ambient - and operator-friendly low-noise design; complete sound - insulating measures

- **During low idle** : **72dB (A)**

New operator's suspension seat

The new-design seat features a high-support structure that always balances and securely holds the operator's body, thus reducing fatigue during extended operation. It also provides retractable seat belt.



Efficient design and functionalities for comfortable operations

- 1 **Integrated, easy-to-Read meter panel to ensure safe operation**
- 2 **Combination switch headlamp and directional Indicator (Auto-return)**
- 3 **Tilttable Steering wheel for operator comfort**



SERVICEABILITY

Large-capacity fuel tank for less frequent fueling; easy-to-see windows for fuel and oil tank inspection

A large-capacity tank reduces fueling frequency and enables extended non-stop operation. Easy-to-see inspection windows, mounted on both the fuel and oil tanks, permit reliable checking of oil and fuel levels as well as the degree of oil contamination.



For oil

For fuel

- **Fuel Tank** (FD100, FD115) : **260L [68.7 USgal]**
- (FD135, FD150E, 160E) : **280L [74.0 USgal]**

Air cleaner with automatic dust ejector to prolong replacement cycle

This air cleaner automatically exhausts air-borne dust to reduce clogging of the filter element, thus enhancing suction efficiency and prolonging the element's replacement cycle.

Reserve tank for maintaining Engine coolant at a constant level (thus eliminating troublesome refilling)



High serviceability: non-bolted floor plates and side covers and quick-open/close engine hood

STRENGTH

A high-rigidity frame for enhanced durability and load-handling performance

Use of a mainframe structure comprising a single, thick steel plate provides high rigidity against twisting caused by static steering, turning, or unevenness of the road surface, thus achieving excellent vehicle durability and load-handling performance.

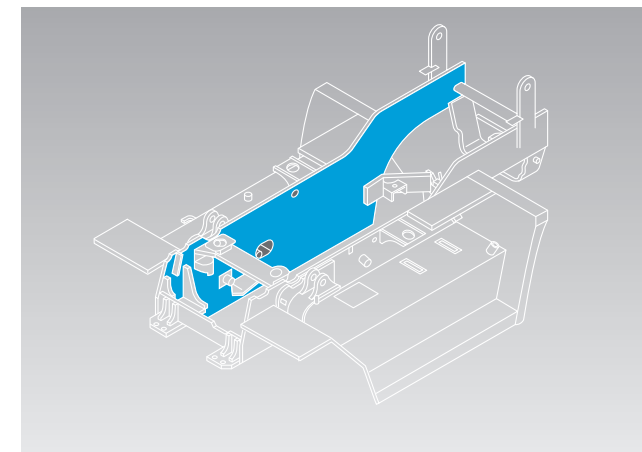

Highly rigid mast construction to ensure reliability

Use of an outer mast of rolled steel rails as well as parts of sufficient strength at every portion of the forklift ensures high strength and durability.

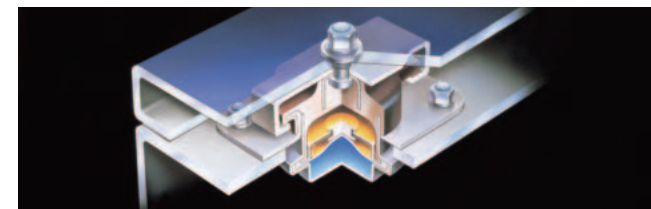

Komatsu's original Hydraulic Suspension Cab (HSC) mount provides the ultimate in operator comfort even during extended operation

Komatsu's original HSC mount system raises the operator's cab from the vehicle body with a hydraulic suspension that absorbs most travel vibration, thereby helping to reduce operator fatigue.

Wide Variety of Attachment & Options to Meet All Your Work application & Environment Needs

Options

| |
|---|
| Automatic Transmission |
| Wet disc brake |
| Operator Presence Sensing system |
| UL specification |
| Cold climate specification (-30 degree) |
| Rotating light |
| Rear working light |
| Speedometer |
| Load indicator |
| Special length forks |
| Extension forks |
| Air cleaner with pre-cleaner |
| Spark arrester |
| Rear under mirror |
| Steel cabin |
| Air conditioner |
| Heater |
| Rotating seat |
| Fuel cap with key |

Steel Cabin



Wide visibility even under severe working conditions for a comfortable and quiet working environment

- Front and rear corners of glass for maximum visibility
- Quick-release door lock lever
- Cabin ceiling-mounted air conditioner for expanded operation space
- A high-mount cabin can be selected for an elevated view depending on the load
- Attachable wipers for front, rear and roof glasses (two wipers for the front glass, window washers for front and rear glasses)
- Built-in high-capacity alternator
- Room illumination

Attachments

| |
|--|
| Side shifter |
| Side shift fork positioner (Independent move) |
| Fork positioner (Independent move) |
| Fork positioner with side shift function (Simultaneous move) |
| Manipulator* |
| Ram* |
| Crane* |
| Pole carrier fork* |
| Furnace charger* |
| Tyre handler* |

*Available upon request

Tyre Handler



Komatsu's exclusive design provide reliability and versatility.

This attachment holds and rotates a huge construction machinery tyre, making the tyre exchange faster and smoother.

Side shifter · Fork positioner



Enhancing forward visibility for smooth fork positioning

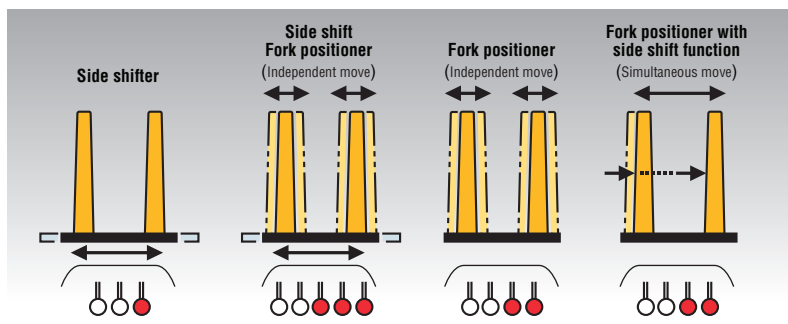

CAPACITY CHART

Maximum Load and Overall Height of Mast by Lifting Height (Double mast, load center: 600mm)

| Model | FD100-8 | | | | FD115-8 | | | | FD135-8 | | | |
|------------|-----------------------------|---|-------------------------|-------------------|-------------------------|---|------------------------|-------------------|-------------------------|---|------------------------|-------------------|
| | Maximum fork height mm (in) | Overall height mm (in) Lowered/Extended | Load capacity* kg (lb) | Free lift mm (in) | Back tilt restriction | Overall height mm (in) Lowered/Extended | Load capacity* kg (lb) | Free lift mm (in) | Back tilt restriction | Overall height mm (in) Lowered/Extended | Load capacity* kg (lb) | Free lift mm (in) |
| 3000 (118) | 2890/4400 (113.8/173.2) | 10000 (22,000) | 0 (0) | 12° | 3160/4670 (124.4/183.9) | 11500 (25,000) | 0 (0) | 12° | 3170/4680 (124.8/184.3) | 13500 (30,000) | 0 (0) | 12° |
| 3300 (130) | 3040/4700 (119.7/185.0) | 10000 (22,000) | 3310/4970 (130.3/195.7) | | 11500 (25,000) | 3320/4980 (130.7/196.1) | | | 13500 (30,000) | | | |
| 3500 (138) | 3140/4900 (123.6/192.9) | 10000 (22,000) | 3410/5170 (134.3/203.5) | | 11500 (25,000) | 3420/5180 (134.6/203.9) | | | 13500 (30,000) | | | |
| 3700 (146) | 3240/5100 (127.6/200.8) | 10000 (22,000) | 3510/5370 (138.2/211.4) | | 11500 (25,000) | 3520/5380 (138.6/211.8) | | | 13500 (30,000) | | | |
| 4000 (157) | 3390/5400 (133.5/212.6) | 10000 (22,000) | 3760/5770 (148.0/219.3) | | 11500 (25,000) | 3770/5780 (148.4/227.6) | | | 13500 (30,000) | | | |
| 4500 (177) | 3740/6000 (147.2/236.2) | 10000 (22,000) | 4010/6270 (157.9/246.8) | | 11500 (25,000) | 4020/6280 (158.3/247.2) | | | 13500 (30,000) | | | |
| 5000 (197) | 4140/6650 (163.0/261.8) | 10000 (22,000) | 4460/6970 (175.6/274.4) | | 11500 (25,000) | 4470/6980 (176.0/274.8) | | | 13500 (30,000) | | | |
| 5500 (217) | 4440/7200 (174.8/283.5) | 9000 (19,800) | 4710/7470 (185.4/294.1) | | 10000 (22,000) | 4720/7480 (185.8/294.5) | | | 12000 (26,500) | | | |
| 6000 (236) | 4690/7700 (184.6/303.1) | 8000 (17,600) | 4960/7970 (195.3/313.8) | | 9000 (19,800) | 4970/7980 (195.7/314.2) | | | 11000 (24,300) | | | |

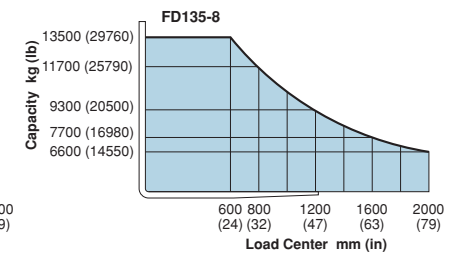
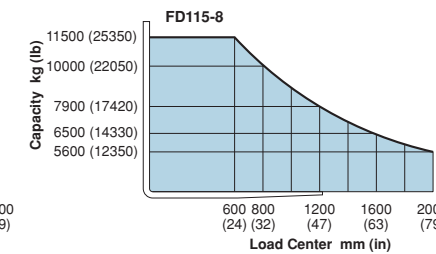
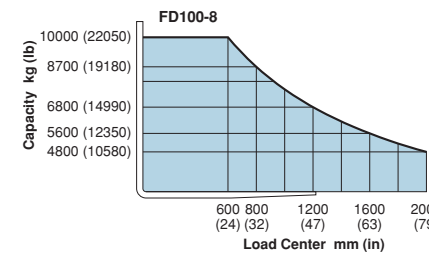

| Model | FD150E-8 | | | | FD160E-8 | | | |
|------------|-----------------------------|---|------------------------|-------------------|-------------------------|---|------------------------|-------------------|
| | Maximum fork height mm (in) | Overall height mm (in) Lowered/Extended | Load capacity* kg (lb) | Free lift mm (in) | Back tilt restriction | Overall height mm (in) Lowered/Extended | Load capacity* kg (lb) | Free lift mm (in) |
| 3000 (118) | 3270/4780 (128.7/188.2) | 15000 (33,000) | 0 (0) | 12° | 3290/4800 (129.5/189.0) | 16000 (35,300) | 0 (0) | 12° |
| 3300 (130) | 3420/5080 (134.6/200.0) | 15000 (33,000) | | | 3440/5100 (135.4/200.8) | 16000 (35,300) | | |
| 3500 (138) | 3520/5280 (138.6/207.9) | 15000 (33,000) | | | 3540/5300 (139.4/208.7) | 16000 (35,300) | | |
| 3700 (146) | 3620/5480 (142.5/215.7) | 15000 (33,000) | | | 3640/5500 (143.3/216.5) | 16000 (35,300) | | |
| 4000 (157) | 3770/5780 (148.4/227.6) | 15000 (33,000) | | | 3790/5800 (149.2/228.3) | 16000 (35,300) | | |
| 4500 (177) | 4020/6280 (158.3/247.2) | 15000 (33,000) | | | 4040/6300 (159.1/248.0) | 16000 (35,300) | | |
| 5000 (197) | 4470/6980 (176.0/274.8) | 15000 (33,000) | | | 4490/7000 (176.8/275.6) | 16000 (35,300) | | |
| 5500 (217) | 4720/7480 (185.3/294.5) | 13500 (29,800) | | | 4740/7500 (186.6/295.3) | 14500 (32,000) | | |
| 6000 (236) | 4970/7980 (195.7/314.2) | 12000 (26,500) | | | 4990/8000 (196.5/315.0) | 13000 (28,700) | | |

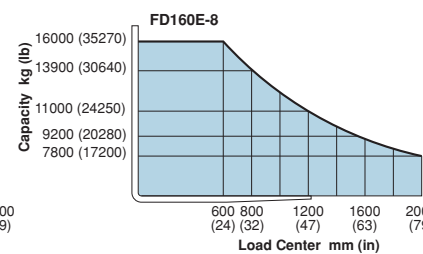
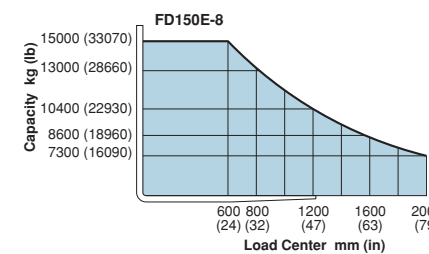

Standard mast is shown in broad frame.
*Load capacity at 600mm (24in.) load center.

Capacities shown are for trucks equipped with 2-stage view mast up through 5000mm (197in.) maximum fork

Performance specifications are affected by the conditions of the vehicle and how it is equipped as well as the nature and conditions of the operating area. If these specifications are critical, please discuss the proposed application with your distributor or dealer.

Specifications

| Characteristics | 1.2 Model | | Manufacturer's Designations | | FD100-8 | FD115-8 | FD135-8 | FD150E-8 | FD160E-8 | 1.2 | |
|---------------------|------------------------------------|--|--|--------------------------|---------------------------|----------------------------|-----------------------------|-----------------------------|----------------------------|----------------------------|------|
| | | 1.3 Power Type | Electric, Diesel, Gasoline, LPG, Cable | | | Diesel | Diesel | Diesel | Diesel | Diesel | 1.3 |
| | 1.4 Operation Type | Pedestrian, Drive Standing, Sitting, Order Picking | | | Sitting | Sitting | Sitting | Sitting | Sitting | 1.4 | |
| | 1.5 Rated Capacity | Q | Rated Capacity | | kg (lb) | 10000 (22,000) | 11500 (25,000) | 13500 (30,000) | 15000 (33,000) | 16000 (35,000) | 1.5 |
| | 1.6 Load Center | c | Rated Load Center | | mm (in) | 600 (24) | 600 (24) | 600 (24) | 600 (24) | 600 (24) | 1.6 |
| | 1.8 Load Distance | x | Front Axle Center to Fork Face | | mm (in) | 695 (27.4) | 715 (28.1) | 740 (29.1) | 750 (29.5) | 750 (29.5) | 1.8 |
| | 1.9 Wheelbase | y | | | mm (in) | 2800 (110.2) | 2800 (110.2) | 3100 (122.0) | 3100 (122.0) | 3100 (122.0) | 1.9 |
| Weight | 2.1 Service Weight | | | | kg (lb) | 12980 (28,620) | 14360 (31,660) | 15480 (34,130) | 16570 (36,530) | 17200 (37,920) | 2.1 |
| | 2.2 Axle Loading | Loaded | Front | kg (lb) | 20860 (45,990) | 23490 (51,790) | 26450 (58,310) | 28740 (63,360) | 30140 (66,450) | 2.2 | |
| | | | Rear | kg (lb) | 2120 (4,670) | 2370 (5,220) | 2530 (5,580) | 2830 (6,240) | 3060 (6,750) | 2.2.1 | |
| | 2.3 | Unloaded | Front | kg (lb) | 6230 (13,730) | 6590 (14,530) | 7110 (15,670) | 7210 (15,900) | 7170 (15,810) | 2.3 | |
| Rear | | | kg (lb) | 6750 (14,880) | 7770 (17,130) | 8370 (18,450) | 9360 (20,640) | 10030 (22,110) | 2.3.2 | | |
| Tyres | 3.1 Tyre Type | | | | Pneumatic | Pneumatic | Pneumatic | Pneumatic | Pneumatic | 3.1 | |
| | 3.2 Tyre Size | Front | | | 9.00-20-14PR (I) | 10.00-20-14PR (I) | 11.00-20-14PR (I) | 11.00-20-16PR (I) | 12.00-20-16PR (I) | 3.2 | |
| | | | | | 9.00-20-14PR (I) | 10.00-20-14PR (I) | 11.00-20-14PR (I) | 11.00-20-16PR (I) | 12.00-20-16PR (I) | 3.3 | |
| | 3.3 | Rear | | | 9.00-20-14PR (I) | 10.00-20-14PR (I) | 11.00-20-14PR (I) | 11.00-20-16PR (I) | 12.00-20-16PR (I) | 3.3 | |
| | 3.5 Number of Wheel | Front/Rear (x=driven) | | | 4x/2 | 4x/2 | 4x/2 | 4x/2 | 4x/2 | 3.5 | |
| | 3.6 Tread, Front | b10 | | | mm (in) | 1700 (66.9) | 1700 (66.9) | 1770 (69.7) | 1770 (69.7) | 1770 (69.7) | 3.6 |
| | 3.7 Tread, Rear | b11 | | | mm (in) | 1900 (74.8) | 1890 (74.4) | 1890 (74.4) | 1890 (74.4) | 1870 (73.6) | 3.7 |
| Dimensions | 4.1 Tilting Angle | α/β | Forward/Backward | | degree | 6/12 | 6/12 | 6/12 | 6/12 | 6/12 | 4.1 |
| | 4.2 Mast Height, Lowered | h1 | with Std. Mast | | mm (in) | 2890 (113.8) | 3160 (124.4) | 3170 (124.8) | 3270 (128.7) | 3290 (129.5) | 4.2 |
| | 4.3 Std. Free Lift | h2 | with Std. Mast from Ground | | mm (in) | 0 (0.0) | 0 (0.0) | 0 (0.0) | 0 (0.0) | 0 (0.0) | 4.3 |
| | 4.4 Std. Lift Height | h3 | with Std. Mast from Ground | | mm (in) | 3000 (118) | 3000 (118) | 3000 (118) | 3000 (118) | 3000 (118) | 4.4 |
| | 4.5 Mast Height, Extended | h4 | with Std. Mast | | mm (in) | 4400 (173.2) | 4670 (183.9) | 4680 (184.3) | 4780 (188.2) | 4800 (189.0) | 4.5 |
| | 4.7 Height, Overhead Guard | h6 | | | mm (in) | 2780 (109.4) | 2800 (110.2) | 2810 (110.6) | 2810 (110.6) | 2830 (111.4) | 4.7 |
| | 4.19 Length, with Std. Forks | l1 | | | mm (in) | 5465 (215.2) | 5505 (216.7) | 5860 (230.7) | 5920 (233) | 6020 (237) | 4.19 |
| | 4.20 Length, to fork face | l2 | | | mm (in) | 4245 (167.1) | 4285 (168.7) | 4640 (182.7) | 4700 (185) | 4800 (189) | 4.20 |
| | 4.21 Width, at tyre | b1 | | | mm (in) | 2280 (89.8) | 2310 (90.9) | 2410 (94.9) | 2410 (94.9) | 2480 (97.6) | 4.21 |
| | 4.22 Forks | s/e/l | Thickness/Width/Lengh | | mm (in) | 75x170x1220 (3.0x6.7x48.0) | 75x185x1220 (3.0x7.3x48.0) | 80x185x1220 (3.1x7.3x48.0) | 85x190x1220 (3.3x7.5x48.0) | 85x210x1220 (3.3x8.3x48.0) | 4.22 |
| | 4.23 Fork Carriage Class | | | | Pin Mount | Pin Mount | Pin Mount | Pin Mount | Pin Mount | 4.23 | |
| | 4.24 Width, Fork Carriage | b3 | | | mm (in) | 2140 (84.3) | 2140 (84.3) | 2210 (87.0) | 2210 (87.0) | 2210 (87.0) | 4.24 |
| | 4.31 Ground Clearance | m1 | Under the Mast | | mm (in) | 250 (9.8) | 250 (9.8) | 260 (10.2) | 250 (9.8) | 270 (10.6) | 4.31 |
| | 4.32 | m2 | at the center of wheelbase | | mm (in) | 325 (12.8) | 345 (13.6) | 350 (13.8) | 350 (13.8) | 370 (14.6) | 4.32 |
| | 4.33 Right Angle Stacking Aisle* | Ast | plus load length | | mm (in) | 4695 (184.8) | 4725 (186.0) | 5090 (200.4) | 5150 (202.8) | 5250 (206.7) | 4.33 |
| 4.35 Turning Radius | Wa | | | mm (in) | 4000 (157.5) | 4010 (157.9) | 4350 (171.3) | 4400 (173.2) | 4500 (177.2) | 4.35 | |
| Performance | 5.1 Travel Speed (FWD) | Loaded, 1st/2nd/3rd | km/h (mph) | | 8.5/18/28 (5.3/11.2/17.4) | 8.5/19/28 (5.3/11.8/17.4) | 9/19.5/27.5 (5.6/12.1/17.1) | 9/19.5/27.5 (5.6/12.1/17.1) | 9.5/20/28 (5.9/12.4/17.4) | 5.1 | |
| | 5.1.1 | Unloaded, 1st/2nd/3rd | km/h (mph) | | 9/20/32 (5.6/12.4/19.9) | 9/21/32 (5.6/13.0/19.9) | 9.5/21/32 (5.9/13.0/20.2) | 9.5/21/32 (5.9/13.0/20.2) | 10/21.5/32 (6.2/13.4/20.5) | 5.1.1 | |
| | 5.2 Lifting Speed | Loaded/Unloaded | mm/s (fpm) | | 470/500 (93/98) | 430/450 (85/89) | 350/375 (69/74) | 325/350 (64/69) | 320/345 (63/68) | 5.2 | |
| | 5.3 Lowering Speed | Loaded/Unloaded | mm/s (fpm) | | 400/500 (78.7/98.4) | 400/500 (78.7/98.4) | 400/500 (78.7/98.4) | 400/400 (79/79) | 400/400 (79/79) | 5.3 | |
| | 5.6 Max. Drawbar Pull | Loaded | kN (lb) | | 89 (20,010) | 87 (19,610) | 85 (19,150) | 80 (18,160) | 80 (18,030) | 5.6 | |
| | 5.8 Max. Gradeability | Loaded 1.5km/h, 3min rating | % | | 40 | 34 | 28 | 25 | 23 | 5.8 | |
| | 5.10 Service Brake | Operation/Control | | | Foot/Hydraulic, Powered | Foot/Hydraulic, Powered | Foot/Hydraulic, Powered | Foot/Hydraulic, Powered | Foot/Hydraulic, Powered | 5.10 | |
| | 5.11 Parking Brake | Operation/Control | | | Hand/Mechanical | Hand/Mechanical | Hand/Mechanical | Hand/Mechanical | Hand/Mechanical | 5.11 | |
| 5.12 Steering | Type | | | Hydraulic Power Steering | Hydraulic Power Steering | Hydraulic Power Steering | Hydraulic Power Steering | Hydraulic Power Steering | 5.12 | | |
| 6.4 Battery | Voltage/Capacity at 5-hour rating | | V/Ah | | 24/80 | 24/80 | 24/80 | 24/80 | 24/80 | 6.4 | |
| Drive | 7.1 Maker/Model | | | | Komatsu SAA6D107E-1 | Komatsu SAA6D107E-1 | Komatsu SAA6D107E-1 | Komatsu SAA6D107E-1 | Komatsu SAA6D107E-1 | 7.1 | |
| | 7.2 Rated Output, SAE net | kW (HP) | | | 122 (164) | 122 (164) | 122 (164) | 122 (164) | 122 (164) | 7.2 | |
| | 7.3 Rated Speed | min ⁻¹ | | | 2200 | 2200 | 2200 | 2200 | 2200 | 7.3 | |
| | 7.3.1 Max Torque, SAE net | N-m (lbf·ft)@min ⁻¹ | | | 575 (424)@1600 | 575 (424)@1600 | 575 (424)@1600 | 575 (424)@1600 | 575 (424)@1600 | 7.3.1 | |
| | 7.4 No. of Cylinder/Displacement | cm ³ (cu.in) | | | 6/6690 (408) | 6/6690 (408) | 6/6690 (408) | 6/6690 (408) | 6/6690 (408) | 7.4 | |
| Others | 7.6 Fuel Tank Capacity | L (US gal) | | | 260 (68.7) | 260 (68.7) | 280 (74.0) | 280 (74.0) | 280 (74.0) | 7.6 | |
| | 8.2 Relief Pressure for Attachment | MPa (psi) | | | 21.6 (3,150) | 21.6 (3,150) | 21.6 (3,150) | 21.6 (3,150) | 21.6 (3,150) | 8.2 | |
| | 8.2.1 Hydraulic Tank Capacity | L (US gal) | | | 180 (48) | 180 (48) | 210 (55) | 210 (55) | 210 (55) | 8.2.1 | |
| | 8.6 Clutch | | | | Torque Converter | Torque Converter | Torque Converter | Torque Converter | Torque Converter | 8.6 | |

*Right Angle Stacking Aisle does not include any operational clearance.
Specifications are subject to change without notice.
The performance values indicated herein represent nominal values obtained under typical operating conditions.

Standard Equipment

Headlights
Turn signal lamps
Charge warning lamps
Safety checker
Hourmeter
Fuel gauge
Torque converter oil temperature gauge
Water temperature gauge
Neutral start function
Brake oil pressure warning buzzer
Torque converter oil cooler
Tiltable steering column
Hydraulic power brake
Horn
Overhead guard
Drawbar pin
Cyclonic air cleaner
Notch-release parking brake
Back-up buzzer
Rear view mirror



Full-open steps



Notch-release parking brake



Head guard with front/rear gutters

Dimensional Drawing

